

# THINKING

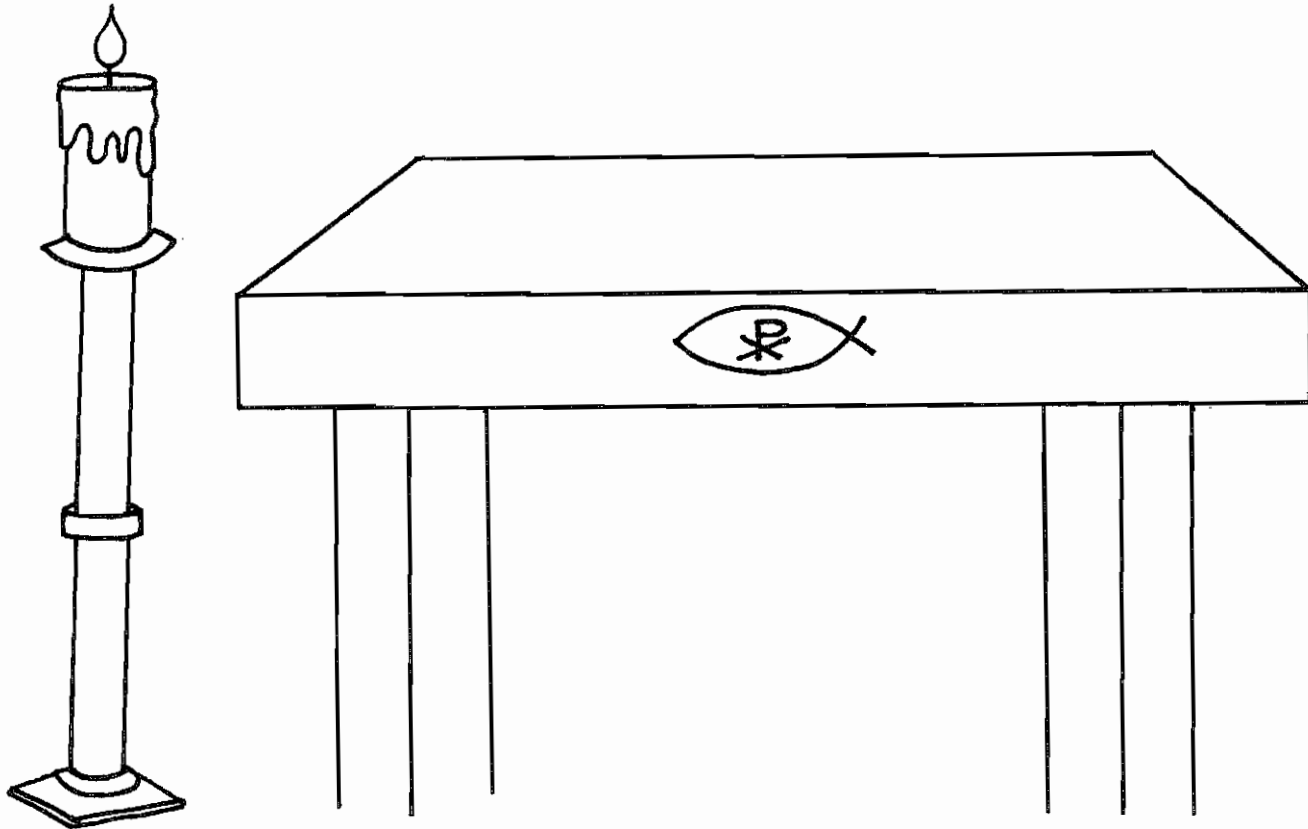

## Discussion:

When you see a burning candle, you can think about Jesus. Do you remember why a burning candle reminds us about our special friend, Jesus? — We feel warm and happy when we see a candle burning. Jesus' words guide us like a candle in the dark.

Jesus said that when two or three people come together to pray, he will be there to listen and pray with them. [Cf. *Mt* 18:20] Jesus is with us when we celebrate God's love for us in church. Although we can't see him, Jesus' spirit of love and goodness is all around us. Jesus helps us to learn about God's love for us. Jesus touches our hearts and helps us to be kind and loving to others.

- Activities:**
- Color the action word THINKING.
  - Add flowers in front of the altar.
  - Color the candle and make it look like it is burning brightly.

# RESPECTING



**Discussion:**

Before we enter the pew in church, we genuflect by touching our right knee to the floor and standing up. Genuflecting when we enter and leave church is a sign of honor and respect we show God.

- Activities:**
- Color the action word RESPECTING.
  - Color the boy and girl in the picture.
  - Practice genuflecting.

# LOOKING

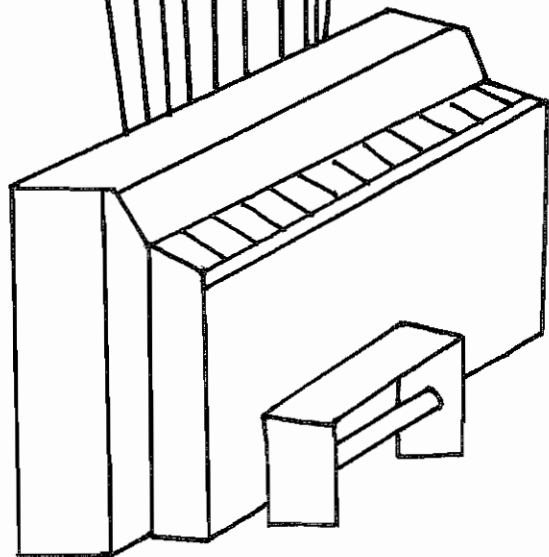
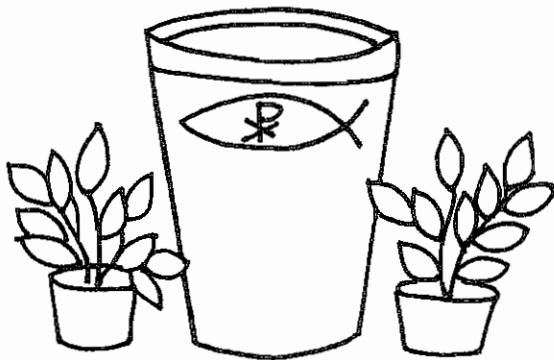
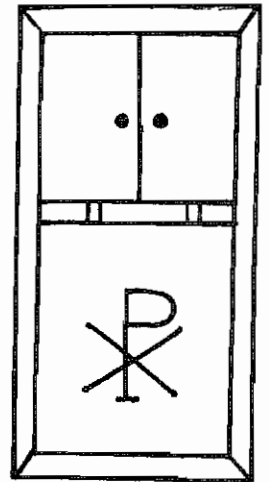
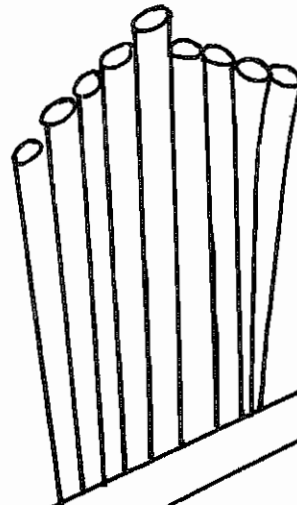
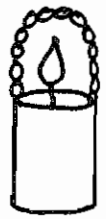

## Discussion:

The church is big, like God's family, so that many people can come to celebrate. The church has many different things in it. Let's take a look around . . .

- **Pews** — Long benches with a back used for people to sit on.
- **Altar** — The name for a special table used by the priest during Mass.
- **Candles** — Burning candles to remind us of Jesus — his words and actions are like a light that guides us and shows us the way.
- **Incense** — Incense is a mixture of perfumes and spices which when burning gives off sweet-smelling smoke. When incense is used during Mass, it reminds us that our prayers and singing rise to God as smoke rises to the sky.
- **Lectern** — The lectern is a reading and a speaking stand near the altar that is used by the Priest and his helpers during the Mass.
- **Lectionary** — The book that has the Bible stories read during the Mass.

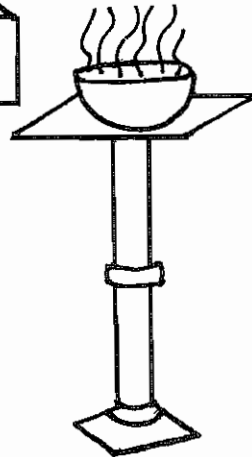
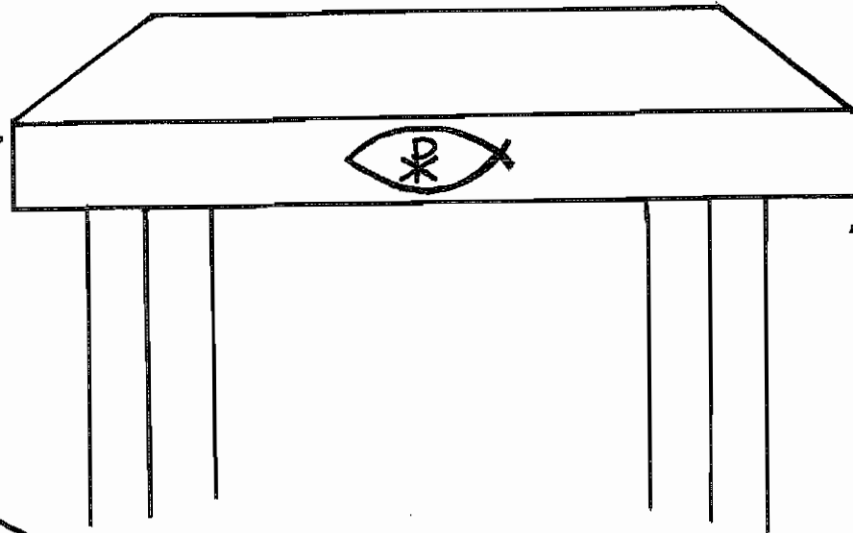
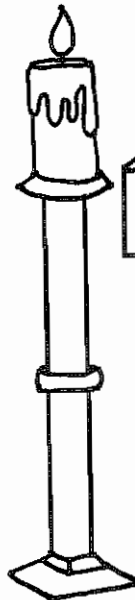
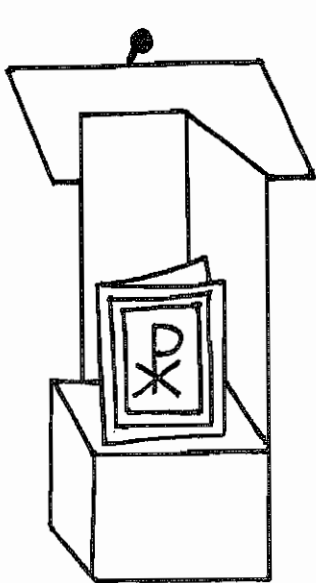
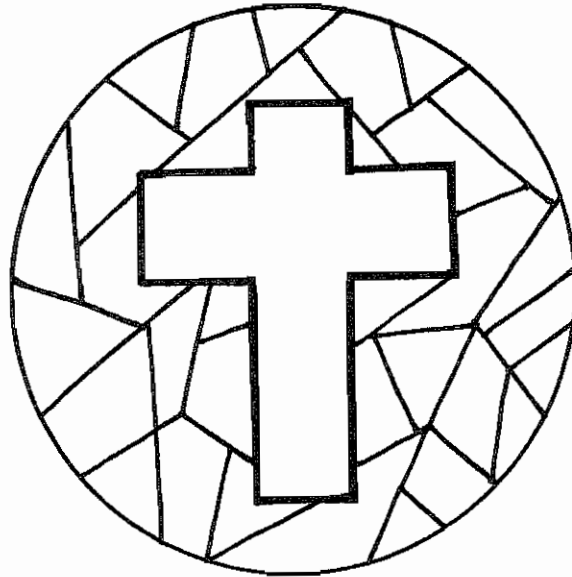
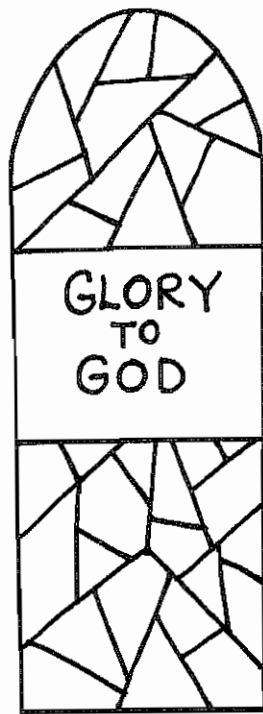

- **Tabernacle** — A locked cabinet where Holy Communion is kept. A burning candle reminds us of Jesus' presence.
- **Choir** — The special place where people gather to lead us in singing during Mass.
- **Baptismal Font** — The container for the water used at Baptism.
- **Statues** — Figures of famous people who loved God very much and are now happy with God in heaven. In this church, there is a statue of Mary, the mother of Jesus, and also a statue of St. Joseph, her husband, who took care of Jesus and Mary.
- **Stained-Glass Windows** — Windows filled with colored pieces of glass are found in many churches. The shining sun brightens the many colors and helps make God's house look special and beautiful.

- Activities:**
- Color the action word **LOOKING**.
  - Visit your parish church with your parent(s) or teacher to look at what your church has inside. What do you see that is not listed on this page?

# Prayers Children Must Know

## Sign of the Cross

In the name of the Father,  
and of the Son,  
and of the Holy Spirit. Amen.

## Hail Mary

Hail Mary, full of grace!  
The Lord is with you;  
blessed are you among  
women and blessed is the  
fruit of your womb Jesus.  
Holy Mary Mother of God,  
pray for us sinners,  
now and at the hour  
of our death. Amen.

## The Lord's Prayer

Our Father, who are in  
heaven, hallowed be Thy  
name. Thy kingdom come,  
Thy will be done on earth  
as it is in heaven.  
Give us this day our daily  
bread; and forgive us our  
trespasses as we forgive  
those who trespass against  
us; and lead us not into  
temptation, but deliver us  
from evil. Amen.

## Glory Be (*Doxology*)

Glory be to the Father,  
and to the Son,  
and to the Holy Spirit  
as it was in the beginning,  
is now, and will be forever.  
Amen.

## Act of Contrition

My God, I am sorry for  
my sins with all my heart.  
In choosing to do wrong  
and failing to do good,  
I have sinned against You whom  
I should love above all things.  
I firmly intend, with Your help,  
to do Penance, to sin no more,  
and to avoid whatever  
leads me to sin.  
Our Savior Jesus Christ  
suffered and died for us.  
In His name, my God,  
have mercy. Amen.

